





# 1-800-BOLLARDS

**The Bollard Experts**

- 12" BOLLARD COVER  
(12" NOMINAL BOLLARD SIZE)
- CSS12010 SCHED 10 STAINLESS STEEL COVER
- STAINLESS STEEL BOLLARD COVER FINISH
- POLISHED #4
- SELECT DESIRED STAINLESS STEEL BOLLARD MATERIAL:
- TYPE 304
- TYPE 316
- SELECT DESIRED BOLLARD CAP STYLE:
-  DOME (SHOWN)
-  STANDARD FLAT
-  REVEAL
-  SLOPED
- COVER HEIGHT SELECTION FROM:
- BASE OF BOLLARD
- TOP OF BOLLARD \_\_\_\_\_ INCHES

REVISIONS			
LTR	DESCRIPTION	DATE	APPVD
COMMENTS			
SPECIFICATIONS			
HEIGHT: 36"			
DIAMETER: 13.00"			
WALL THICKNESS: 0.180"			

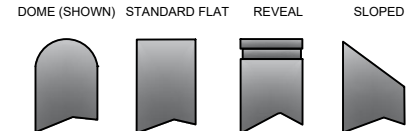
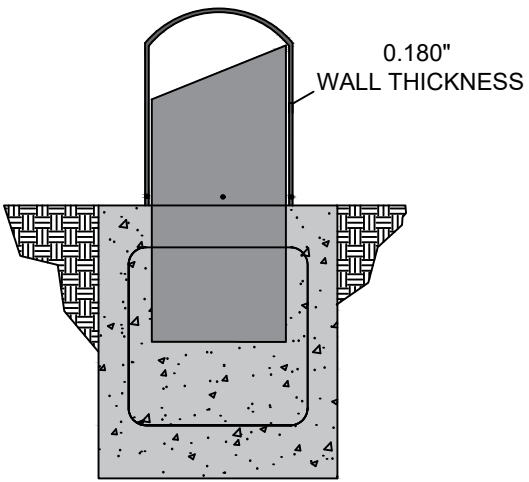
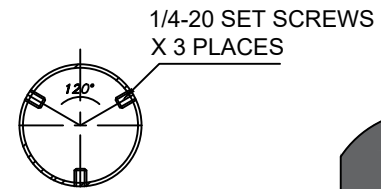
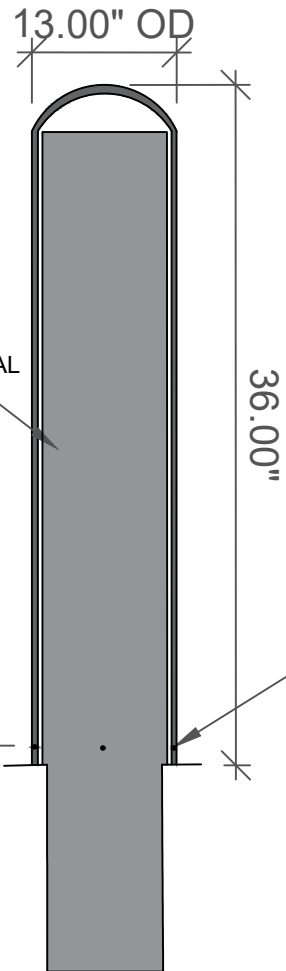
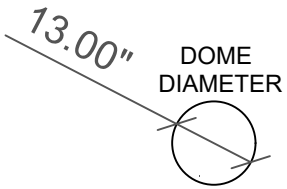

NOTES:  
 1. INSTALLATION TO BE COMPLETED IN ACCORDANCE WITH MANUFACTURER'S SPECIFICATIONS.  
 2. DO NOT SCALE DRAWING.  
 3. THIS DRAWING IS INTENDED FOR USE BY ARCHITECTS, ENGINEERS, CONTRACTORS, CONSULTANTS AND DESIGN PROFESSIONALS FOR PLANNING PURPOSES ONLY. THIS DRAWING MAY NOT BE USED FOR CONSTRUCTION.  
 4. ALL INFORMATION CONTAINED HEREIN WAS CURRENT AT THE TIME OF DEVELOPMENT BUT MUST BE REVIEWED AND APPROVED BY THE PRODUCT MANUFACTURER TO BE CONSIDERED ACCURATE.  
 5. CONTRACTOR'S NOTE: FOR PRODUCT AND COMPANY INFORMATION VISIT [www.1800bollards.com/info](http://www.1800bollards.com/info) AND ENTER REFERENCE NUMBER 0046-027.

APPLICATION		SERIES NUMBER: YX-S060-XX		CAGE CODE: 6NGJB		REV: 6th Cutsheet Size A - R1	
NEXT ASSY	USED ON	PRODUCT FAMILY: FIXED BOLLARD	PRODUCT CLASS: STANDARD OR CUSTOMER DEFINED	PRODUCT LINE: BOLLARD	PRODUCT SUB LINE: COVER	DRAWN BY: AJA	DRAWING REV: 1
		1-800-BOLLARDS, Inc. 10 Hughes Suite A105 Irvine, CA 92618 PHONE: 1-800-BOLLARDS WEB: <a href="http://www.1800bollards.com">www.1800bollards.com</a> EMAIL: <a href="mailto:info@1800bollards.com">info@1800bollards.com</a>				CHECKED BY:	APPROVED BY:
						TITLE: BOLLARD, COVER	